

A-A

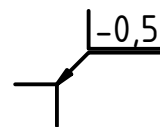
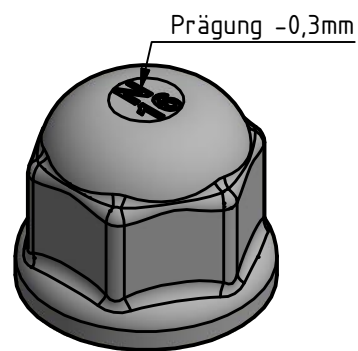
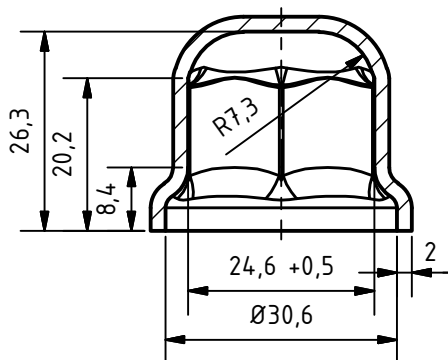

Schutzvermerk ISO 16016 beachten

Bezeichnung:
Sicherungsmuffe DIN 125 - M16

Datum:
08.11.2022

WBI STEELPLUS
GMBH

Material:
DC01

Rohmaß:

Name:
MS

Maßstab: 1 : 1
Kanten: ISO 13715

Allgemeintoleranzen:
ISO 2768 - fK

Oberflächenangaben:
DIN ISO 1302

