

A-A

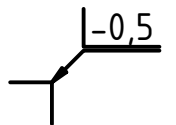
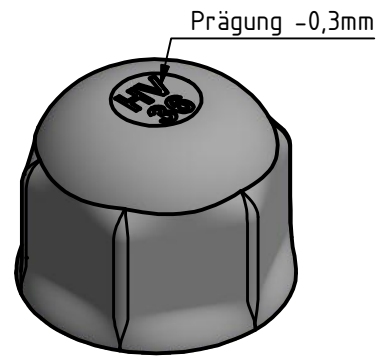
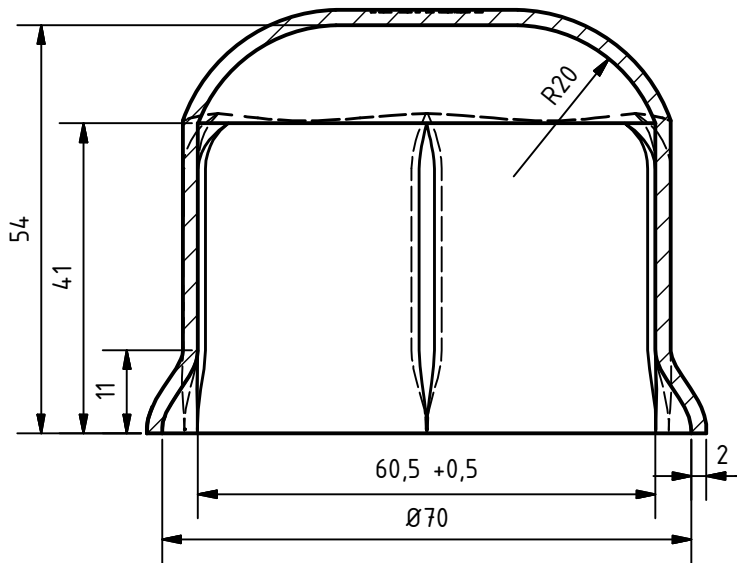

Schutzvermerk ISO 16016 beachten

Bezeichnung:  
Sicherungsmuffe HV M36

Datum:  
08.11.2022

**WBI** STEELPLUS  
GMBH

Material:  
DC01

Rohmaß:

Name:  
MS

Maßstab: 1 : 1  
Kanten: ISO 13715

Allgemeintoleranzen: ISO 2768 - fK

Oberflächenangaben: DIN ISO 1302

